

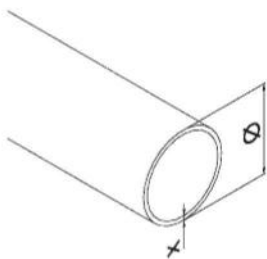

Anniversary
30TH since 1988
COFERINOX
ACCESSORI E RACCORDI

Tubo satinato	CODICE	Φ	MATERIALE	PREZZO
Barre da	CF_11-200-33	Φ 33,7	aisi 304	
3/6 mt.	CF_11-201-42	Φ 42,4	aisi 304	
	CF_11-202-48	Φ 48,3	aisi 304	



Raccordo angolo 90°	CODICE	Φ	MATERIALE	H	PREZZO
	CF_11-203-33	Φ 33,7	aisi 304	35	
	CF_11-204-42	Φ 42,4	aisi 304	44	
	CF_11-205-48	Φ 48,3	aisi 304	44	

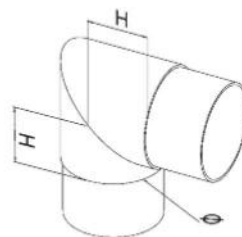

Raccordo angolo 90°	CODICE	Φ	MATERIALE	PREZZO
	CF_11-206-33	Φ 33,7	aisi 304	26
	CF_11-207-42	Φ 42,4	aisi 304	29
	CF_11-208-48	Φ 48,3	aisi 304	36

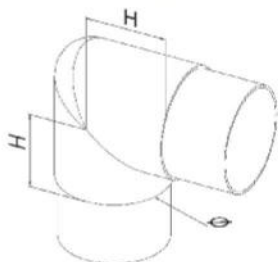

Raccordo angolo 90°	CODICE	Φ	MATERIALE	H	PREZZO
	CF_11-209-33	Φ 33,7	aisi 304	35	
	CF_11-210-42	Φ 42,4	aisi 304	45	
	CF_11-211-48	Φ 48,7	aisi 304	50	

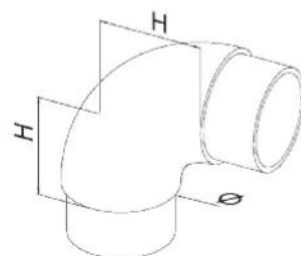

Raccordo a 3 vie	CODICE	Φ	MATERIALE	PREZZO
	CF_11-212-33	Φ 33,7	aisi 304	24
	CF_11-213-42	Φ 42,4	aisi 304	30
	CF_11-214-48	Φ 48,3	aisi 304	36

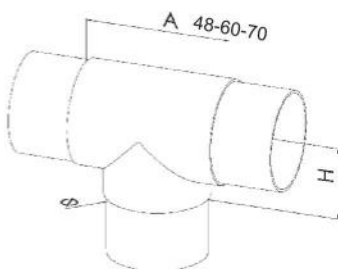

Raccordo a 3 vie	CODICE	Φ	MATERIALE	H	PREZZO
	CF_11-215-33	Φ 33,7	aisi 304	25	
	CF_11-216-42	Φ 42,4	aisi 304	28	
	CF_11-217-48	Φ 48,3	aisi 304	36	

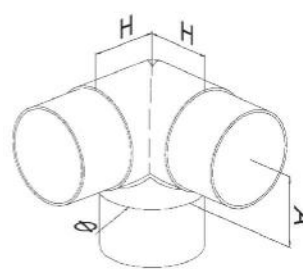

Raccordo snodato	CODICE	Φ	MATERIALE	PREZZO
	CF_11-218-33	Φ 33,7	aisi 304	21
	CF_11-219-42	Φ 42,4	aisi 304	27
	CF_11-220-48	Φ 48,3	aisi 304	29

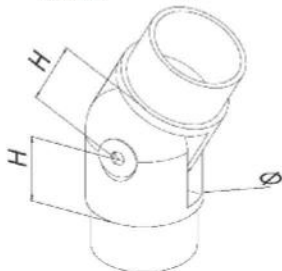

Raccordo snodato a parete	CODICE	Φ	MATERIALE	H	PREZZO
	CF_11-221-33	Φ 33,7	aisi 304	21	
	CF_11-222-42	Φ 42,4	aisi 304	26	
	CF_11-223-48	Φ 48,3	aisi 304	28	

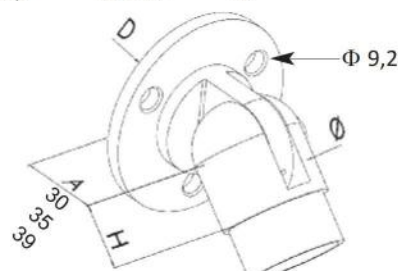

Raccordo ad angolo variabile	CODICE	Φ	MATERIALE	PREZZO
	CF_11-224-33	Φ 33,7	aisi 304	
	CF_11-225-42	Φ 42,4	aisi 304	
	CF_11-226-48	Φ 48,3	aisi 304	

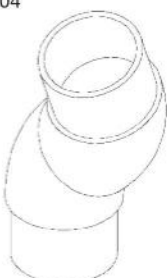

Raccordo ad angolo 135°	CODICE	Φ	MATERIALE	H	PREZZO
	CF_11-227-33	Φ 33,7	aisi 304	25	
	CF_11-228-42	Φ 42,4	aisi 304	41	
	CF_11-229-48	Φ 48,3	aisi 304	35	

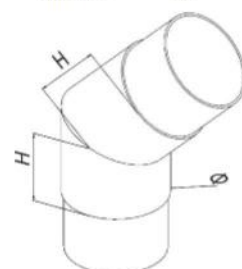

Giunzione per tubo	CODICE	Φ	MATERIALE	PREZZO
	CF_11-230-33	Φ 33,7	aisi 304	
	CF_11-231-42	Φ 42,4	aisi 304	
	CF_11-232-48	Φ 48,3	aisi 304	

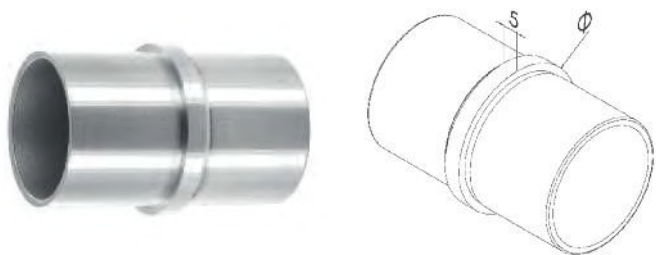

Attacco a parete	CODICE	Φ	MATERIALE	H	PREZZO
	CF_11-233-33	Φ 33,7	aisi 304	35	
	CF_11-234-42	Φ 42,4	aisi 304	44	
	CF_11-235-48	Φ 48,3	aisi 304	44	

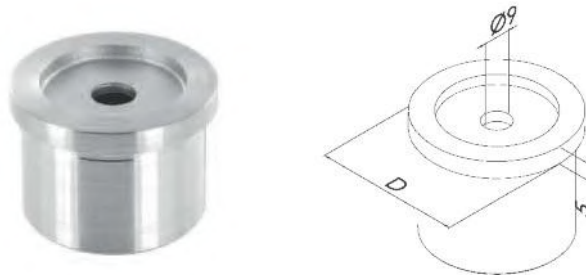

Attacco a parete	CODICE	Φ	MATERIALE	PREZZO
	CF_11-236-33	Φ 33,7	aisi 304	26
	CF_11-237-42	Φ 42,4	aisi 304	29
	CF_11-238-48	Φ 48,3	aisi 304	36

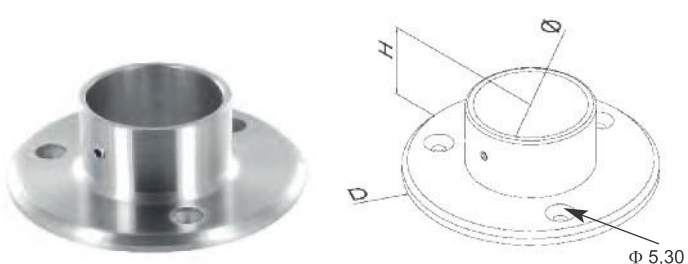

Raccordo montante per corrimano	CODICE	Φ	MATERIALE	H	PREZZO
	CF_11-239-33	Φ 33,7	aisi 304	35	
	CF_11-240-42	Φ 42,4	aisi 304	45	
	CF_11-241-48	Φ 48,7	aisi 304	50	

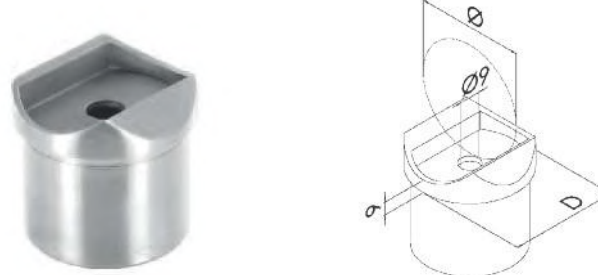

Attacco a parete	CODICE	Φ	MATERIALE	PREZZO
	CF_11-242-33	Φ 33,7	aisi 304	24
	CF_11-243-42	Φ 42,4	aisi 304	30
	CF_11-244-48	Φ 48,3	aisi 304	36

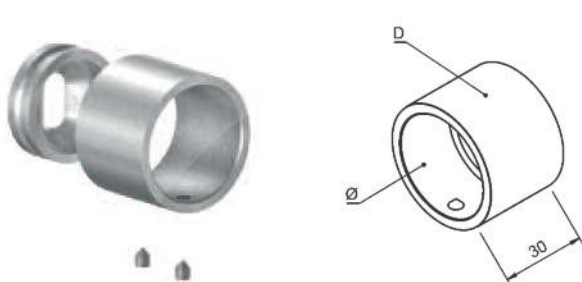

Attacco a tubo	CODICE	Φ	MATERIALE	H	PREZZO
	CF_11-245-33	Φ 33,7	aisi 304	25	
	CF_11-246-42	Φ 42,4	aisi 304	28	

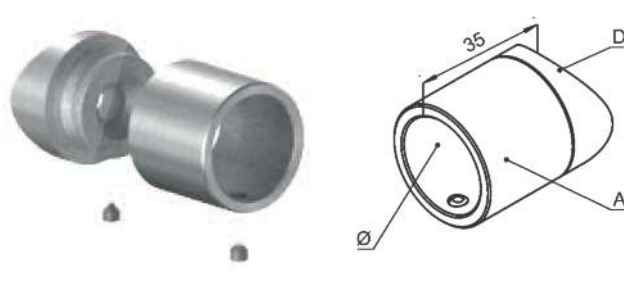

Terminale curvo 90° bombato	CODICE	Φ	MATERIALE	PREZZO
	CF_11-247-33	Φ 33,7	aisi 304	21
	CF_11-248-42	Φ 42,4	aisi 304	27
	CF_11-249-48	Φ 48,3	aisi 304	29



Terminale snodato a parete	CODICE	Φ	MATERIALE	H	PREZZO
	CF_11-250-33	Φ 33,7	aisi 304	21	
	CF_11-251-42	Φ 42,4	aisi 304	26	
	CF_11-252-48	Φ 48,3	aisi 304	28	

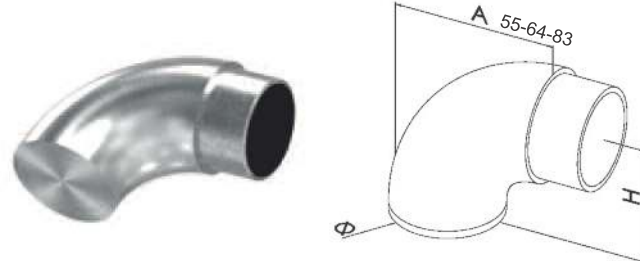

Terminale bombato	CODICE	Φ	MATERIALE	PREZZO
	CF_11-253-33	Φ 33,7	aisi 304	
	CF_11-254-42	Φ 42,4	aisi 304	
	CF_11-255-48	Φ 48,3	aisi 304	

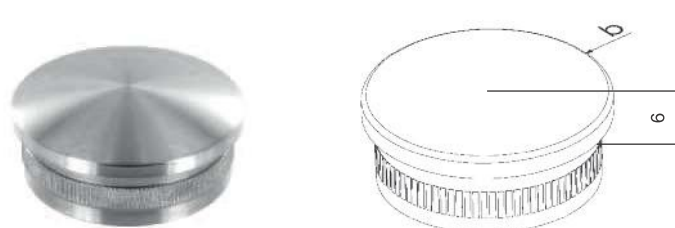

Terminale sferico	CODICE	Φ	MATERIALE	PREZZO
	CF_11-256-33	Φ 33,7	aisi 304	
	CF_11-257-42	Φ 42,4	aisi 304	
	CF_11-258-48	Φ 48,3	aisi 304	

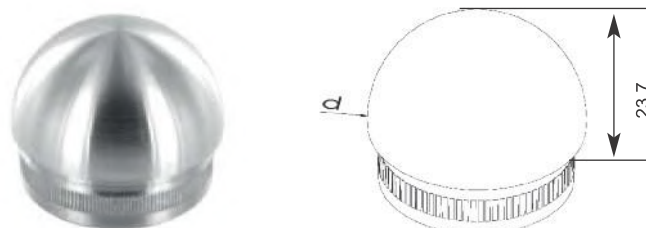

Sostegno per corrimano con perno fisso e piastra di collegamento

COD.	Φ	H.	MAT.	PR.
CF_11-259-33	33,7	- 80mm	aisi 304	
CF_11-260-42	42,4	- 80mm	aisi 304	

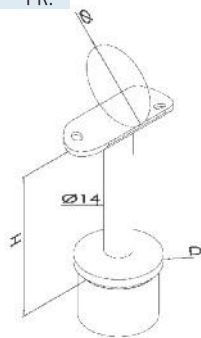

Sostegno per corrimano con perno snodabile e piastra di collegamento

COD.	Φ	H.	MAT.	PR.
CF_11-261-33	33,7	- 80mm	aisi 304	
CF_11-262-42	42,4	- 80mm	aisi 304	

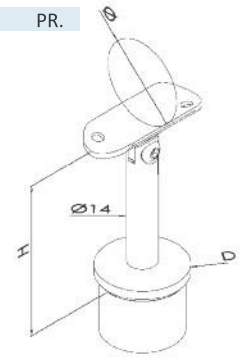

Sostegno per corrimano fisso con perno fisso e piastra di collegamento 90°

COD.	Φ	H.	MAT.	PR.
CF_11-263-33	42,4	- 77mm	aisi 304	
CF_11-264-42	42,4	- 134mm	aisi 304	

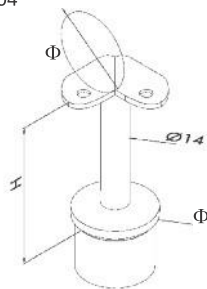

Sostegno per corrimano fisso con piastra di ancoraggio e piastra di collegamento

COD.	Φ	H.	MAT.	PR.
CF_11-265-42	42,4	- 77mm	aisi 304	
CF_11-266-42	42,4	- 134mm	aisi 304	

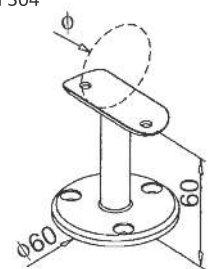

Sostegno per corrimano snodabile

COD.	Φ	H.	MAT.	PR.
CF_11-267-33	33,7	- 50mm	aisi 304	
CF_11-268-42	42,4	- 58mm	aisi 304	
CF_11-269-48	48,3	- 59mm	aisi 304	

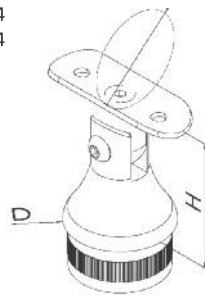

Sostegno per corrimano fisso

COD.	Φ	H.	MAT.	PR.
CF_11-270-33	33,7	- 50mm	aisi 304	
CF_11-271-42	42,4	- 58mm	aisi 304	
CF_11-272-48	48,3	- 59mm	aisi 304	

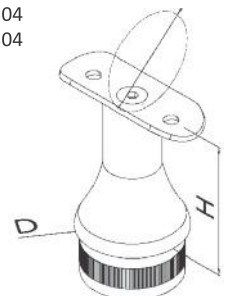

Piastra di collegamento snodabile

COD.	Φ	MAT.	PR.
CF_11-273-33	33,7	- aisi 304	
CF_11-274-P	piatto	-aisi 304	

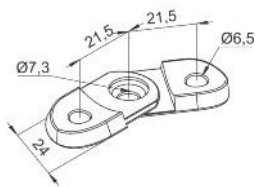

Sostegno per corrimano con perno fisso

COD.	Φ	H.	MAT.	PR.
CF_11-275-33	33,7	- 50mm	aisi 304	
CF_11-276-42	42,4	- 58mm	aisi 304	
CF_11-277-48	48,3	- 59mm	aisi 304	

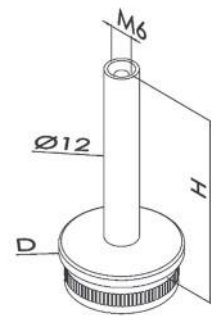

Piastra di collegamento

COD.	Φ	MAT.	PR.
CF_11-278-33	33,7	aisi 304	
CF_11-279-42	42,4	aisi 304	
CF_11-280-48	48,3	aisi 304	
CF_11-281-P	piatto	aisi 304	

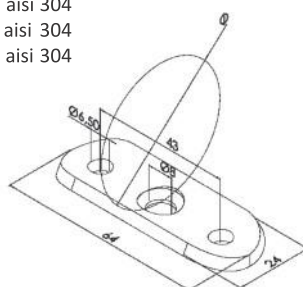

Piastra di collegamento 90°

COD.	Φ	MAT.	PR.
CF_11-282-33	33,7	aisi 304	
CF_11-283-42	42,4	aisi 304	

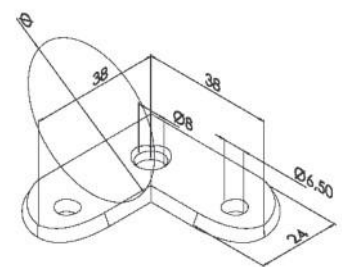

Tondino pieno Φ 10/12

COD.	Φ	MAT.	PR.
CF_11-284-10	10	aisi 304	
CF_11-285-12	12	aisi 304	

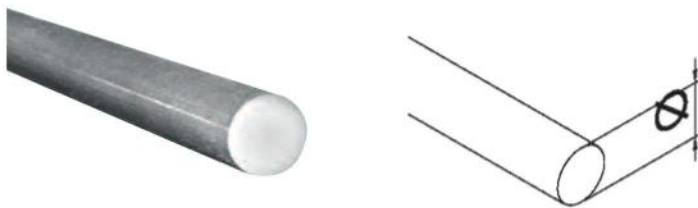

Snodo tondino Φ 10/12 base piatta o tubolare Φ 33,7/42,4

COD.	Φ	D.	MAT.	PR.
CF_11-286-10	10 piatto	aisi 304		
CF_11-287-10	12 piatto	aisi 304		
CF_11-288-12	12 42,4	aisi 304		

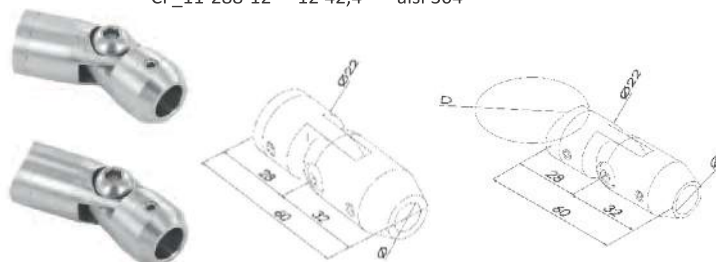

Snodo per tondino Φ 10/12

COD.	Φ	MAT.	PR.
CF_11-289-10	10	aisi 304	
CF_11-290-12	12	aisi 304	



Attacco tondino Φ 10/12 base piatta o tubolare Φ 33,7/42,4

COD.	Φ	D.	MAT.	PR.
CF_11-293-10	10 piatto	aisi 304		
CF_11-294-12	12 piatto	aisi 304		
CF_11-291-10	10 42,4	aisi 304		
CF_11-292-12	12 42,4	aisi 304		

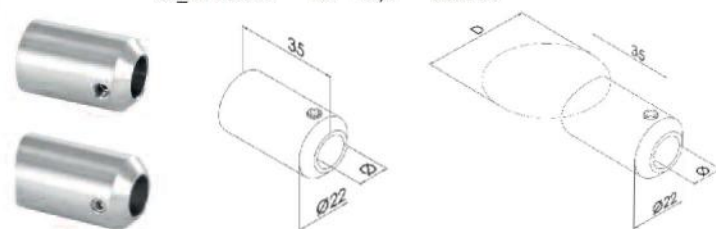

Supporto tondino Φ 10/12 base piatta

COD.	Φ	MAT.	PR.
CF_11-295-10	10 piatto	aisi 304	
CF_11-296-12	12 piatto	aisi 304	



Supporto tondino Φ 10/12 base per tubo Φ 33,7/42,4

COD.	Φ	D.	MAT.	PR.
CF_11-297-10	10 42,4	aisi 304		
CF_11-298-12	12 42,4	aisi 304		

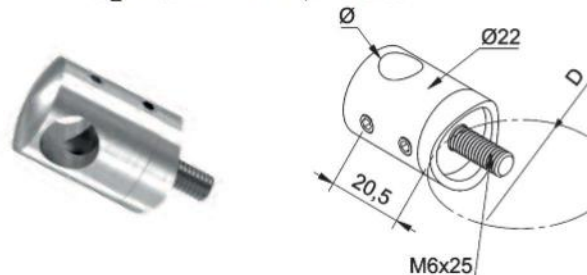

Supporto tondino angolo esterno

COD.	Φ	D.	MAT.	PR.
CF_11-299-42	12	42,4	aisi 304	

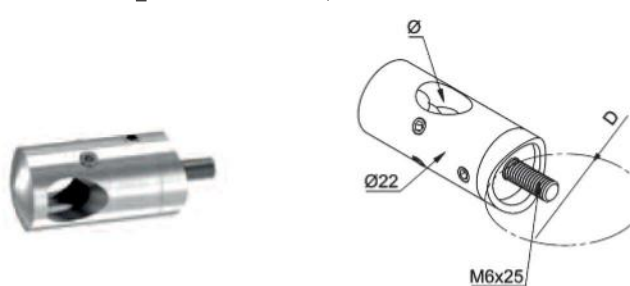

Supporto tondino angolo interno

COD.	Φ	D.	MAT.	PR.
CF_11-300-42	12	42,4	aisi 304	

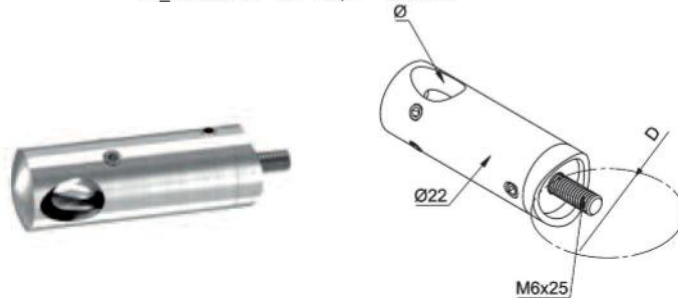

Supporto tondino cieco destro Φ 10/12 base piatta o tubolare Φ 33,7/42,4

COD.	Φ	D.	MAT.	PR.
CF_11-301	10	piatto	aisi 304	
CF_11-301-42	10	42,4	aisi 304	
CF_11-302	12	piatto	aisi 304	
CF_11-302-42	12	42,4	aisi 304	

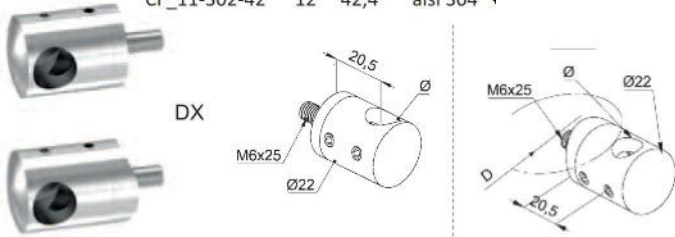
Supporto tondino cieco sinistro Φ 10/12 base piatta o tubolare Φ 33,7/42,4

COD.	Φ	D.	MAT.	PR.
CF_11-303	10	piatto	aisi 304	
CF_11-303-4210		42,4	aisi 30	
CF_11-304	12	piatto	aisi 304	
CF_11-304-4212		42,4	aisi 304	

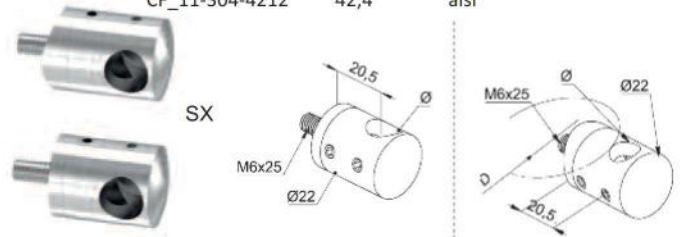
Tappo sferico per tondo Φ 10/12

COD.	Φ	MAT.	PR.
CF_11-305	10	aisi 304	
CF_11-306	12	aisi 304	

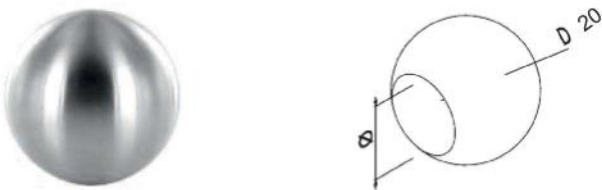
Tappo bombato per tondo Φ 10/12

COD.	Φ	MAT.	PR.
CF_11-307	10	aisi 304	
CF_11-308	12	aisi 304	

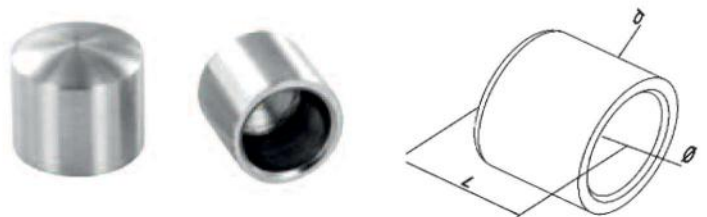

Piastra a saldare grezza d. 100

COD.	Φ	MAT.	PR.
CF_11-309	33,7	aisi 304	
CF_11-310	42,4	aisi 304	
CF_11-311	48,3	aisi 304	

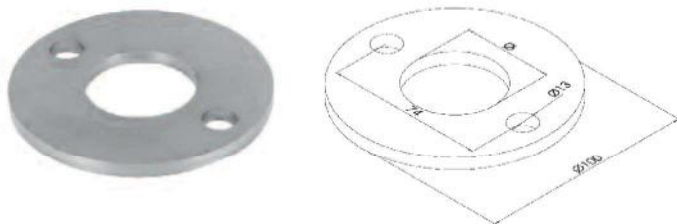

Piastra a saldare grezza d. 100

COD.	Φ	MAT.	PR.
CF_11-312	42,4	aisi 304	

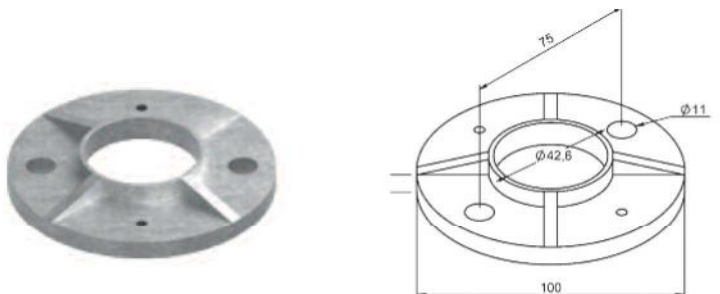

Staffa fissaggio laterale piantane

COD.	Φ	MAT.	PR.
CF_11-313	33,7	aisi 304	
CF_11-314	42,4	aisi 304	
CF_11-315	48,3	aisi 304	

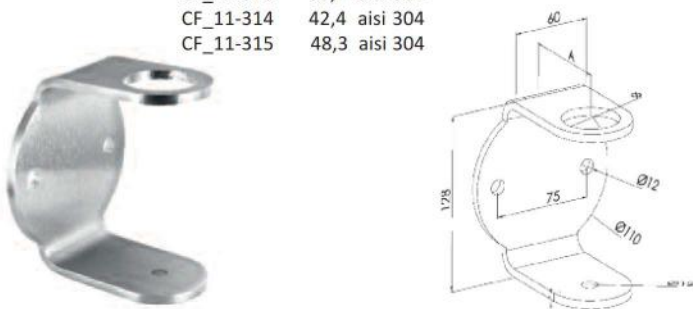

Staffa fissaggio laterale piantane

COD.	Φ	MAT.	PR.
CF_11-316	33,7	aisi 304	
CF_11-317	42,4	aisi 304	
CF_11-318	48,3	aisi 304	

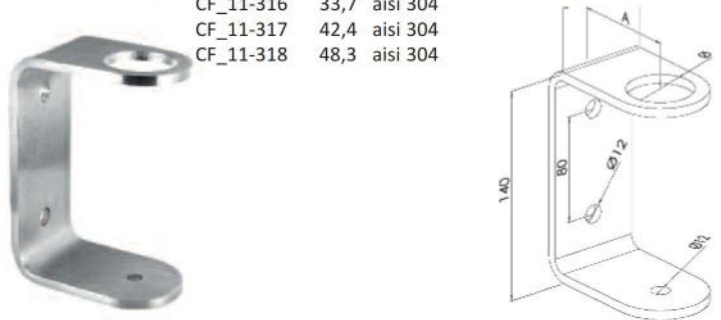

Staffa fissaggio pavimento per piantane

COD.	Φ	MAT.	PR.
CF_11-319	33,7	aisi 304	
CF_11-320	42,4	aisi 304	
CF_11-321	48,3	aisi 304	



Copri piastra

COD.	Φ	MAT.	PR.
CF_11-322	33,7	aisi 304	
CF_11-323	42,4	aisi 304	
CF_11-324	48,3	aisi 304	

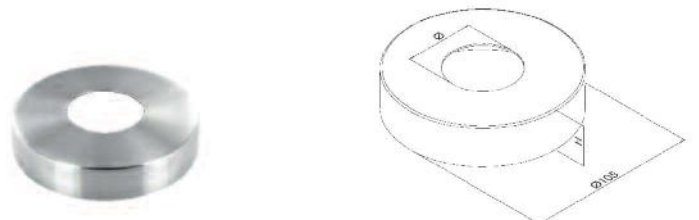

Reggicorrimano a parete fisso

COD.	Φ	MAT.	PR.
CF_11-325	42,4	aisi 304	†

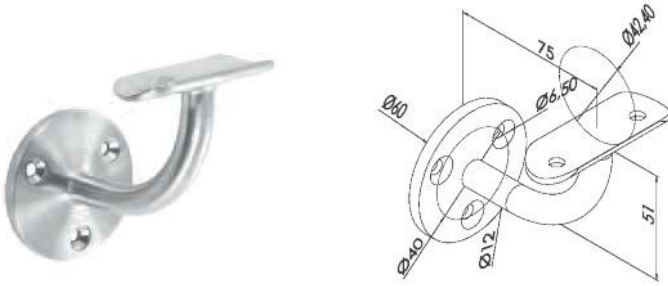

Reggicorrimano a parete snodato

COD.	Φ	MAT.	PR.
CF_11-326	33,7	aisi 304	
CF_11-327	42,4	aisi 304	
CF_11-328	48,3	aisi 304	

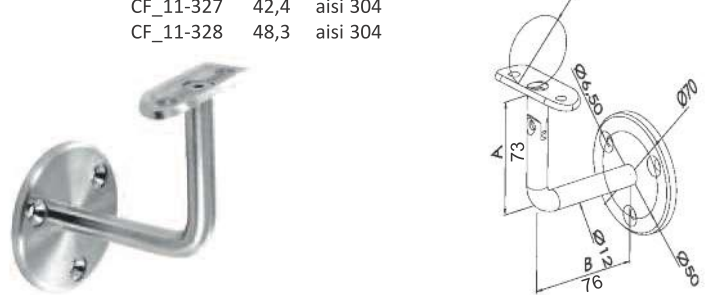

Reggicorrimano a parete fisso

COD.	Φ	MAT.	PR.
CF_11-329	33,7	aisi 304	
CF_11-330	42,4	aisi 304	
CF_11-331	48,3	aisi 304	

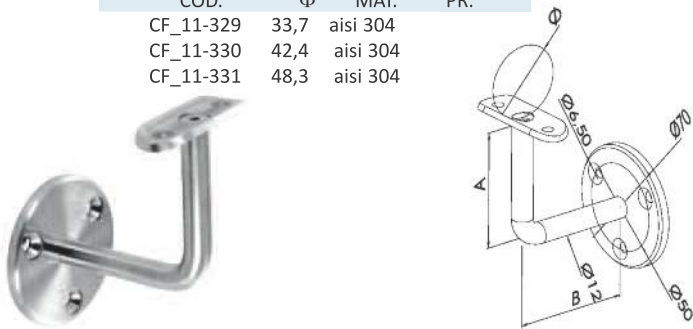

Reggicorrimano a parete da saldare

COD.	Φ	H.	MAT.	PR.
CF_11-332	42,4	77mm	aisi 304	†

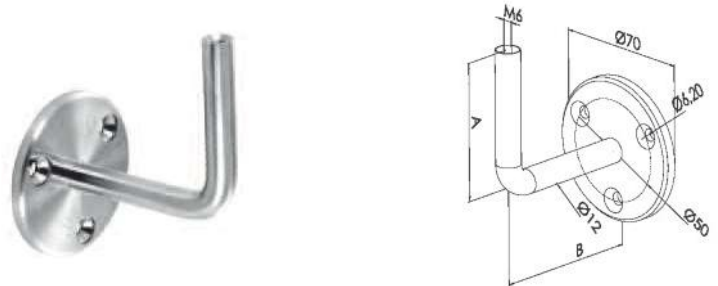

Reggicorrimano a parete fisso regolabile

COD.	Φ	MAT.	PR.
CF_11-333	piatto	aisi 304	
CF_11-334	42,4	aisi 304	

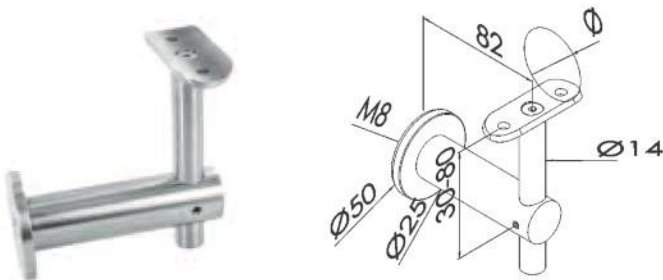

Reggicorrimano a parete snodato regolabile

COD.	Φ	MAT.	PR.
CF_11-335	piatto	aisi 304	
CF_11-336	42,4	aisi 304	

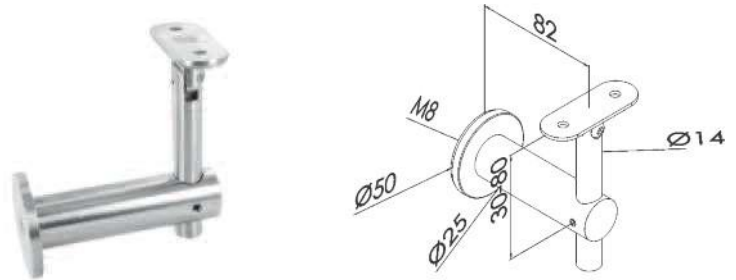

Reggicorrimano su vetro fisso regolabile

COD.	Φ	MAT.	PR.
CF_11-337	piatto	aisi 304	
CF_11-338	42,4	aisi 304	

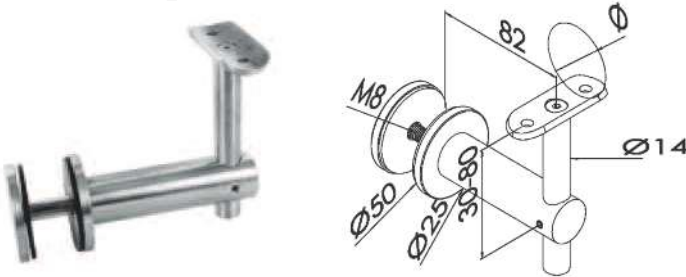

Reggicorrimano su vetro snodato regolabile

COD.	Φ	MAT.	PR.
CF_11-339	piatto	aisi 304	
CF_11-340	42,4	aisi 304	

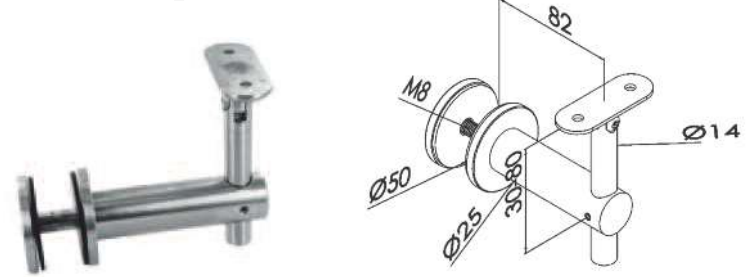

Reggicorrimano a parete fisso

COD.	Φ	MAT.	PR.
CF_11-341	piatto	aisi 304	
CF_11-342	42,4	aisi 304	



Reggicorrimano su tubo Snodato regolabile

COD.	Φ	MAT.	PR.
CF_11-343	/piatto/	aisi 304/	
CF_11-344	/42,4/	aisi 304/	

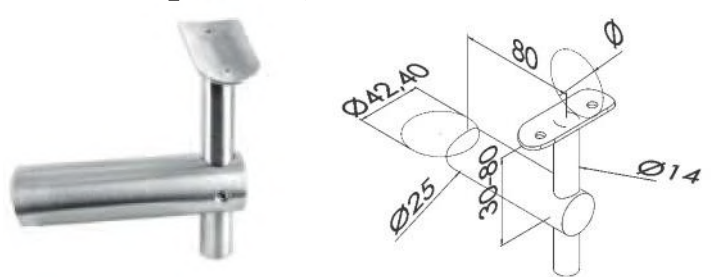

Corrimano in legno

COD.	Φ	L.	MAT.	PR.
CF_11-345-42	42	2000mm	Faggio	
CF_11-346-42	42	3000mm	Faggio	
CF_11-347-42	42	4000mm	Faggio	
CF_11-348-42	42	2000mm	Rovere	
CF_11-349-42	42	3000mm	Rovere	
CF_11-350-42	42	2000mm	Larice	
CF_11-351-42	42	3000mm	Larice	

Terminale per corrimano in legno (incl. 1 adattatore)

COD.	Φ	MAT.	PR.
CF_11-352-42	42,4	aisi 304	



Raccordo per corrimano in legno (incl. 2 adattatori)

COD.	Φ	MAT.	PR.
CF_11-353-42	42,4	aisi 304	



Raccordo 90° per corrimano in legno (incl. 2 adattatori)

COD.	Φ	MAT.	PR.
CF_11-354-42	42,4	aisi 304	

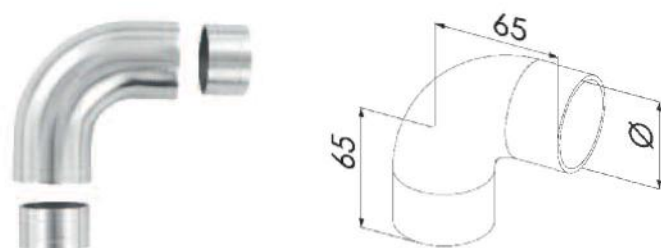

Terminale per corrimano in legno (incl. 1 adattatore)

COD.	Φ	MAT.	PR.
CF_11-355-42	42,4	aisi 304	



Giunzione snodata per corrimano in legno (incl. 2 adattatori)

COD.	Φ	MAT.	PR.
CF_11-356-42	42,4	aisi 304	



Adattatore per corrimano in legno

COD.	Φ	MAT.	PR.
CF_11-357-42	42,4	aisi 304	

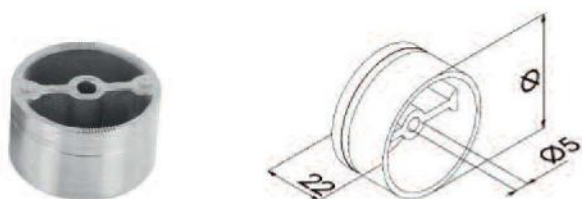

Dima per l'adattatore per corrimano in legno

COD.	Φ	MAT.	PR.
CF_11-358-42	42,4	aisi 304	



Colla per raccordi in acciaio 50/10 ml.

COD.	PR.
CF_11-127-50	
CF_11-127-10	

